

Article number: 604146010037

Description: Timing belt pulley with hub
10 XL 037

Measures

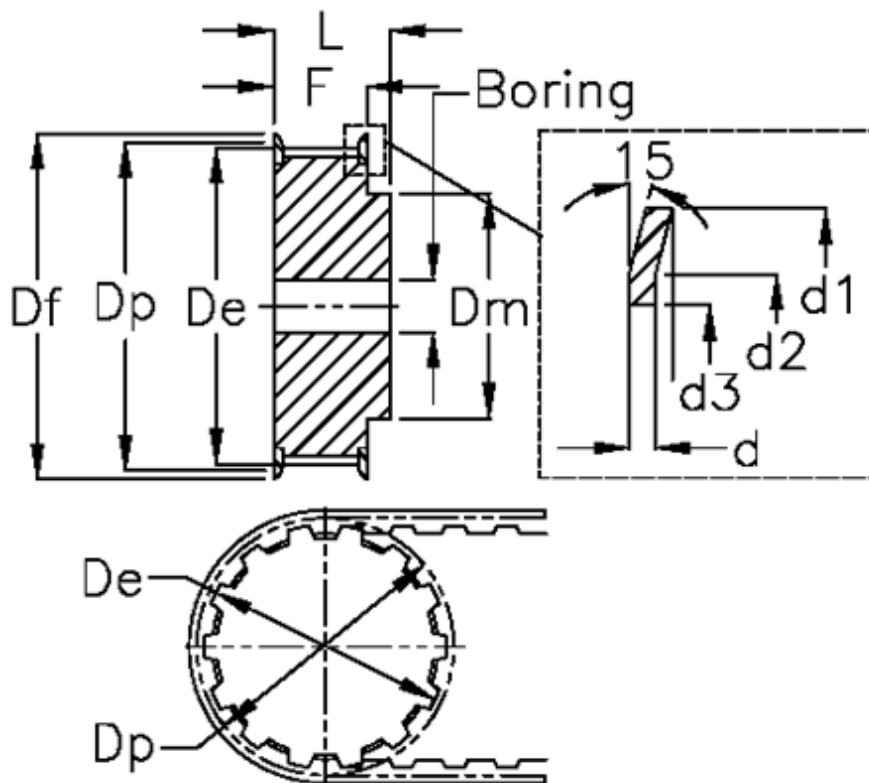

d = 1	F = 14.3	Width = XL 037
d1 = 23	Flange type = F07	
d2 = 18	L = 19.8	
d3 = 12.5	Max bore = 6.4	
De = 15.66	Pitch = 1/5"	
Df = 23	Pre-drilled = 4	
Dm = 9.5	Tooth number = 10	
Dp = 16.17	Weight = 0.02	